

Half-timbered kitchen “house”

by Polyhymnia camp

(a sub-division of the Barony-Marche of the Debatable Lands)

(Disclaimer: This article is informative in nature and is not intended to serve as a set of construction documents. The structure was designed for a specific use by a specific group of people and may not be suitable for use by others in other circumstances. Anyone basing a similar structure on this discussion assumes all risks and liabilities unto him/herself.)

What it is: A walled structure with a canvas roof, in the style of a Tudor half-timbered house from the 15th-16th century.



Figure 1 – Kitchen Seen from South-East



Figure 2 – Kitchen Seen From North

Why we built it: Our camp has been gradually increasing its percentage of period structures over the years. The last remaining communal structure that was modern instead of period was a dining fly attached to our kitchen pantry tent. We wanted something that both looked more period and would be particularly stable in a storm, as it would contain the cooking stoves.

Design and Construction: The house was designed by Master Johan von Traubenberg and constructed by numerous members of the camp. It had to be at least somewhat portable, though once at Cooper’s Lake it won’t be going far as we have on-site storage through the year. Here are the decisions we made and why:

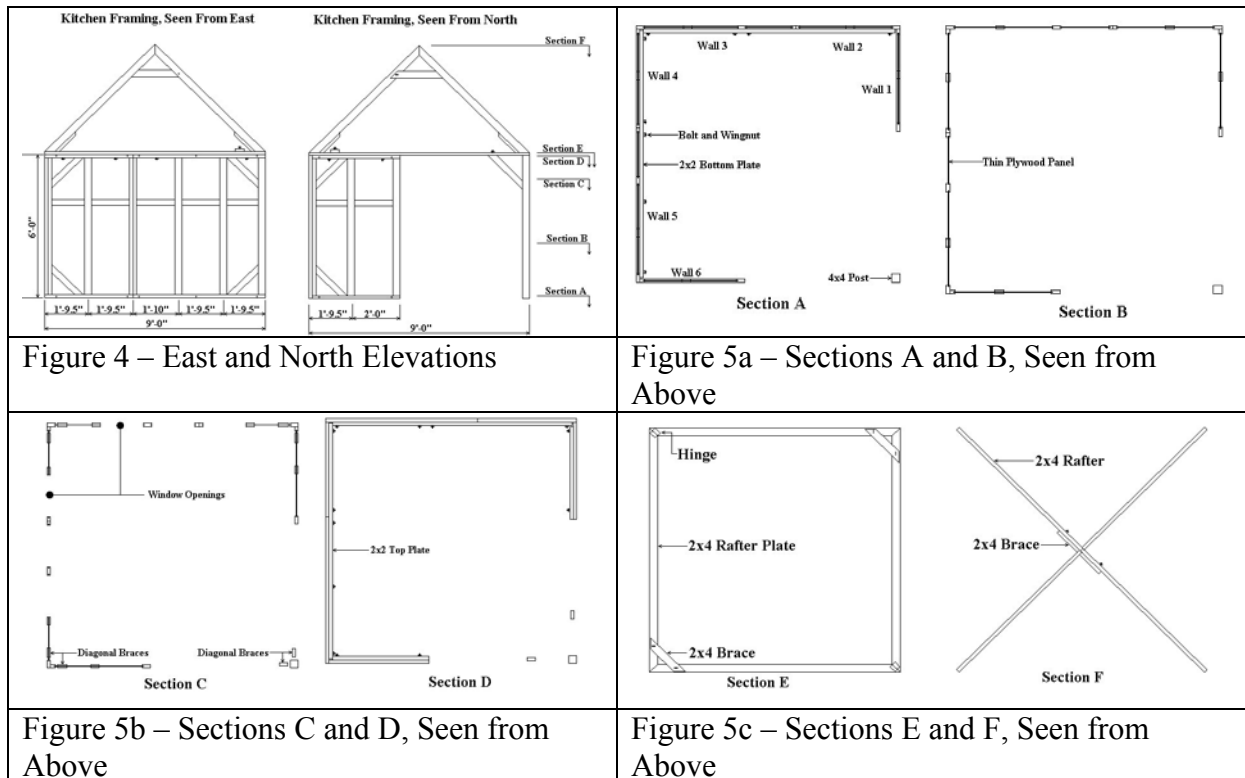

Figure 3 – Kitchen Interior from North

- The supporting beams are 2 by X stock where the timbers would have been in period, and plywood painted white to look like plaster in the area that would have been wattle and daub. The beams were painted brown to resemble the blackened oak of the period.

- Some of the “timbers” are not structural but merely decorative. This was also done in period.
- The roof is canvas. In period, it would have been thatch, slate or tile. Thatch burns easily and requires a lot of maintenance, while slate and tile are too heavy for this portable structure. Painting the canvas to look like slate would be straightforward.
- The house has two walls that are only half-length for ventilation purposes and because it is intended to sit beside our pantry tent, and so needed two exits.
- To increase portability, the walls are in three hinged pieces. They are bolted together with braces of 2 x 2 stock at the tops and bottoms, then hinged 2 x 4s run along the top edges to further stiffen the walls as well as provide support for the hinged roof rafters.
- The rafters are braced with shorter 2 x 4s. A post made of two 2 x 4’s glued and screwed together supports the corner that does not have a wall.
- The pieces are numbered with Roman numerals for ease of assembly, as was done in period as well.
- The canvas roof ties to the roof supports, as do the window shades.
- A period home would have had wood shutters; since our structure will only be used in the summer, we substituted roll-down cloth shades.
- The interior has a chandelier of electric candles (again, for fire safety reasons) and places to hang pots, equipment and cooking supplies like spices.

Elevations and Plan Sections:



Fabricating and Assembling the Wall Sections: The kitchen is constructed of 6 panels framed with 2x2, 2x4 and 1x4 whitewood stock (See Figure 6). The infill is made of 1/8” thick luan mahogany plywood. Nailing plates were used to attach the frame pieces to each other. Any

standard method of wood framing would have been appropriate for this modern structure. The period building would have been put together with mortise and tennon joints fastened with wooden pegs.

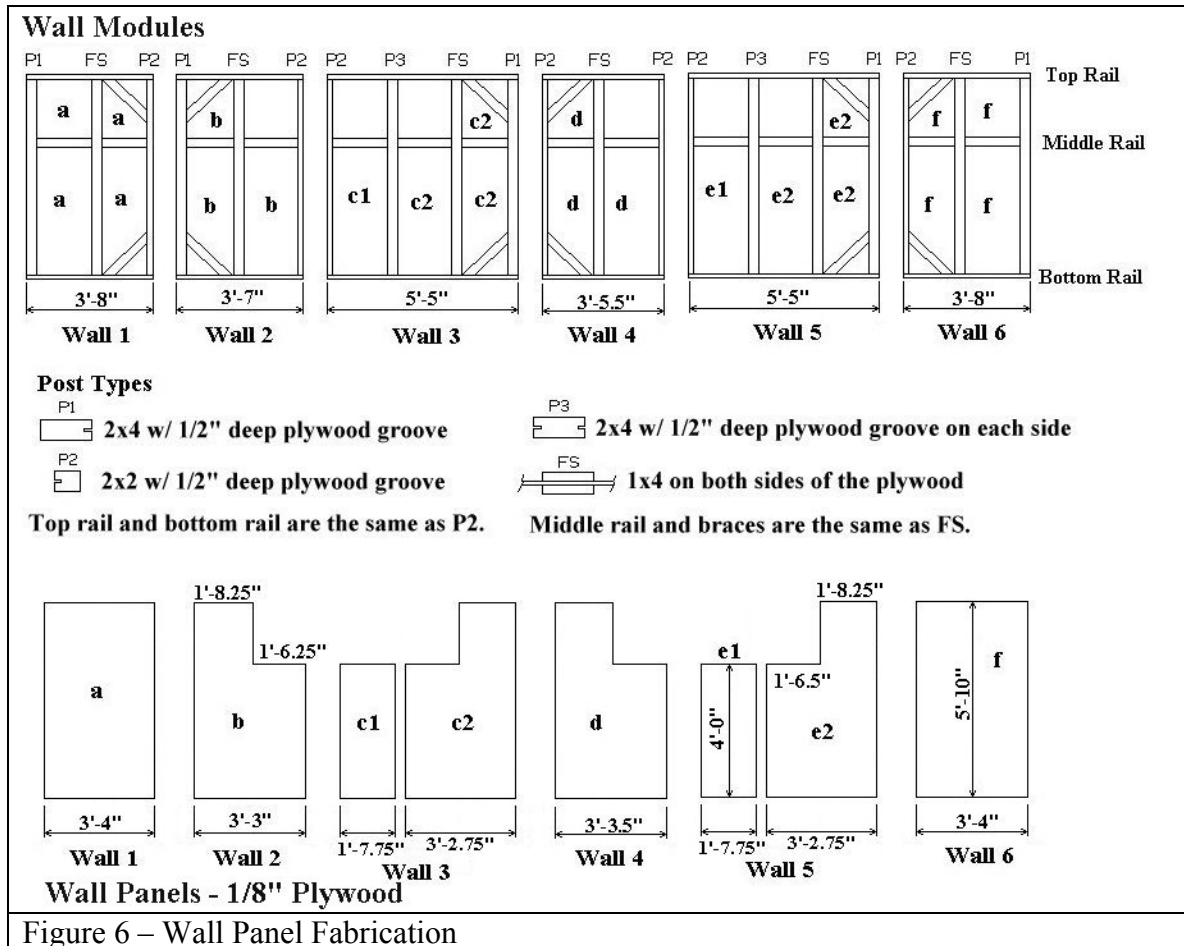
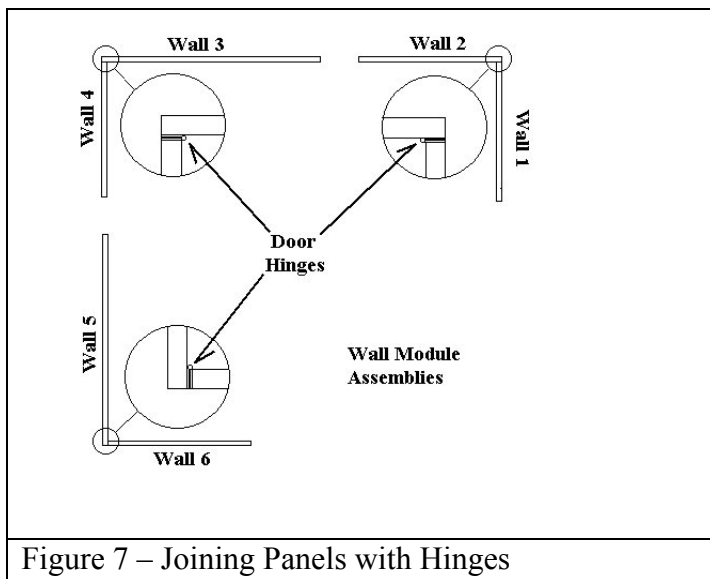

Figure 6 – Wall Panel Fabrication



Pairs of panels were connected together using two standard door hinges for each pair of panels. (See Figure 7) The hinges were arranged such that the two walls would fold flat for storage.

Fabricating and Assembling the Corner Post: (Figure 8) Three corners of the roof of this structure are supported by the wall assemblies. The other corner is supported by a braced post. This post can be either a 4x4 or two 2x4s fastened together. The braces are cut from 2x4s and fastened into place with lag screws. For more strength, the braces could be mortised into the post.

Two headless lag screws were set into the top of the post with about 1.5" protruding to anchor the Rafter plates.

Fabricating and Assembling the Rafter Plates: (Figure 9) The rafter plates sit on top of the walls and the corner post, anchoring them together. They also provide a foundation for the rafters.

After the four identical rafter plates are cut, they are connected together in pairs with standard door hinges, such that one rafter plate can be folded flat onto the other. The two braces were attached during final assembly. The socket holes to fit the lagscrews on top of the post were drilled during final assembly.

Fabricating and Assembling the Rafters: (Figure 10) The rafters were made of 2x4s. Note that there are two long rafters and two short rafters. Scraps of 2x2 were used to construct bird's mouths at the base of the rafters. All rafters were cut to 12/12 pitch (45 degree angle).

After the rafters were cut, they were joined in pairs (one short rafter and one long rafter) using standard door hinges.

A headless lag screw was set into the end of one of the long rafters, protruding approximately 1 inch. A hole was drilled into the end of the other long rafter for the lag screw to socket into. The brace was attached as part of the final assembly of the structure.

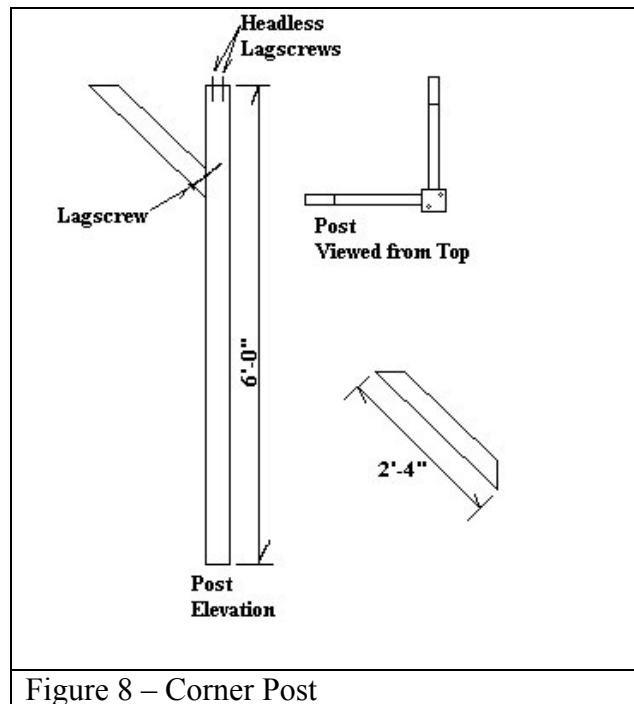

Figure 8 – Corner Post

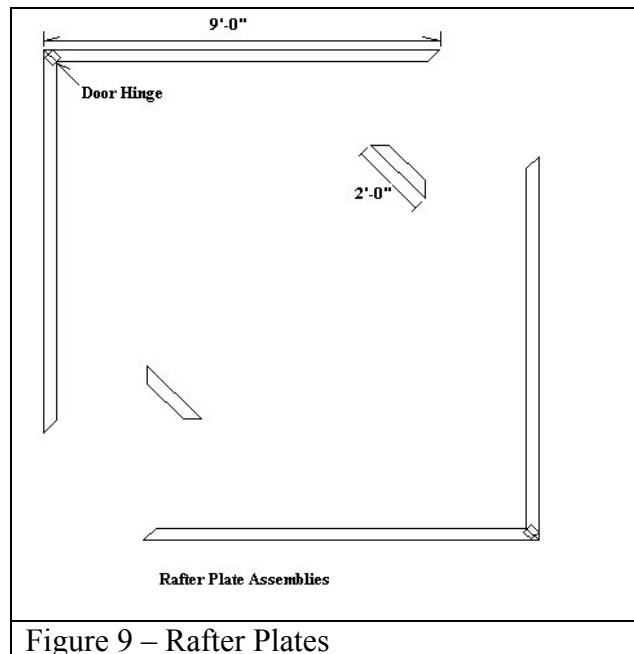

Figure 9 – Rafter Plates

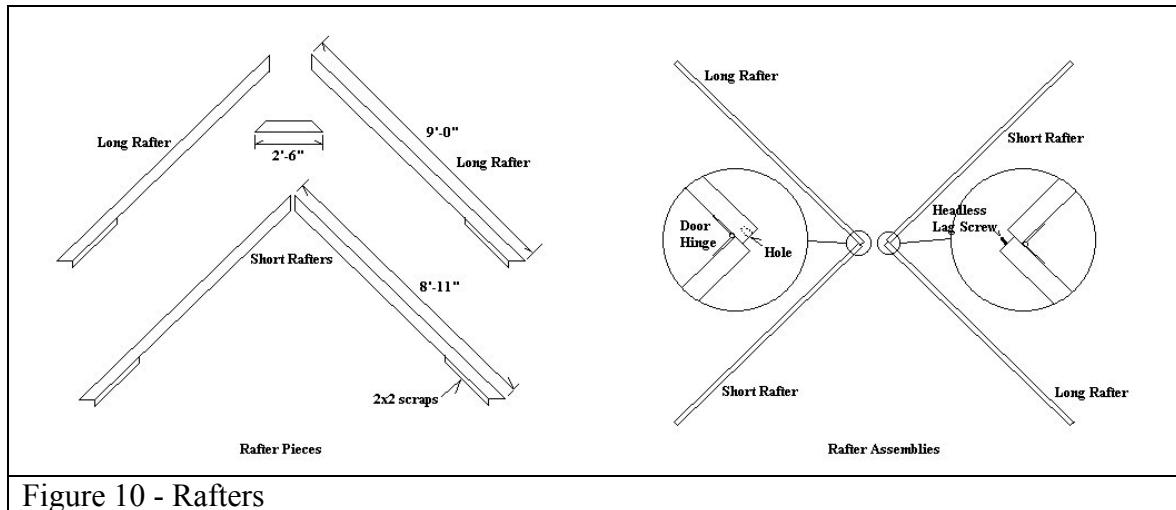

Figure 10 - Rafters

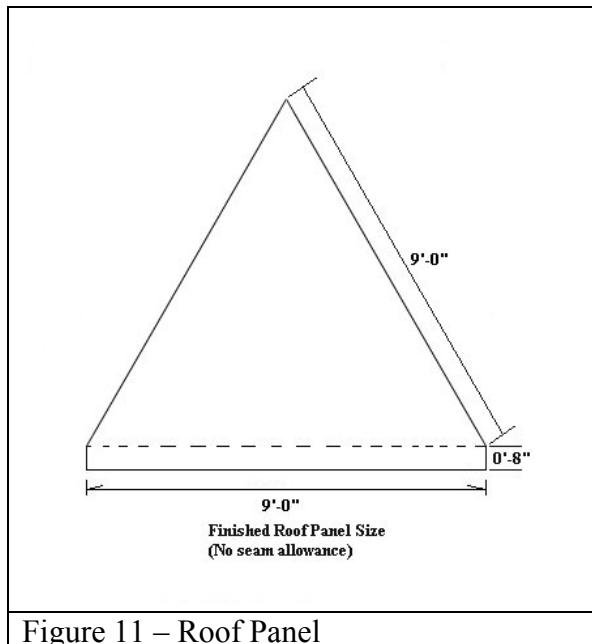

Figure 11 - Roof Panel

Fabric Roof: (Figure 11) The roof was constructed of four canvas panels, each made of two pieces of fabric. The overall shape of each panel was an equilateral triangle, with an overhang attached. The four panels were sewed together to form a hip roof shape. Fabric ties were attached at the eave point and tied around the rafter plate to secure the fabric to the structure. Note that Figure 11 does not include seam allowances, which are needed for assembly.

Putting It All Together: Assembling the kitchen the first time required the use of an electric drill, as the carriage bolts and wing nuts used to assemble the structure had not been placed. Normal assembly thereafter simply required bolting the structure together. The pieces were painted before final assembly.

Step 1: The three wall units were set up on a flat piece of ground in approximately their finished locations. Setting them on small scraps of 2x4 made it easier to reach the bottom rail.

Step 2: Two 2x2 bottom plates (See Figure 5a, Section A) were positioned against the inside of the 2x2 bottom rails of the walls (so that the bottom plate and the bottom rail together made up a horizontal 2x4) and clamped in place. Holes were drilled as shown for 3/8" carriage bolts. The bolts were inserted and fastened with wing nuts. The 2x4 blocks under the bottom rails were removed.

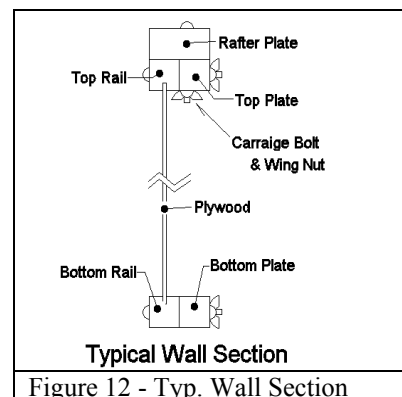

Figure 12 - Typ. Wall Section

Step 3: Four 2x2 top plates (See Figure 5b, Section D) were positioned against the inside of the 2x2 top rails of the walls (so that the top plate and the top rail together made up a horizontal 2x4) and clamped in place. Holes were drilled as shown for 3/8" carriage bolts. The bolts were inserted and fastened with wing nuts.

Step 4: The Rafter Plates (See Figure 5c, Section E) were positioned on top of the assembled walls and clamped in place. Holes were drilled through the rafter plates and the top plates/rails for 3/8" carriage bolts. The bolts were inserted and fastened with wing nuts. Longer bolts were used to attach the corner braces, as shown.

Step 5: The Corner Post was positioned under the remaining corner of the rafter plates. The headless lag screws in the top of the post socketed into holes in the bottom of the corner plates. The post braces were fastened into place with carriage bolts.

Step 6: The rafters were lifted into place on top of the rafter plate. The easiest way to do this seems to be:

- With the rafters in one set folded against each other, the foot of one of the long rafters was set in place.
- The other set of rafters was positioned so that the lag screw at the top of one large rafter engaged the socket on the other. That rafter was then pushed up until the foot could be set into position.
- The short rafters were unfolded and put them in place.

Once the rafters were in place, the brace was positioned against the two long rafters and bolted into place.

Step 7: The canvas was pulled over the frame, and the ties on the canvas tied around the rafter plate/top plate/top rail assembly.

Step 8: The window curtains were hung from the rafter plate/top plate/top rail assembly and the chandelier hung from the rafter brace.